

Varenummer: 20090166

Beskrivelse: E+G Bøjlegreb GN 565.4-26-160-A-EL

Mål

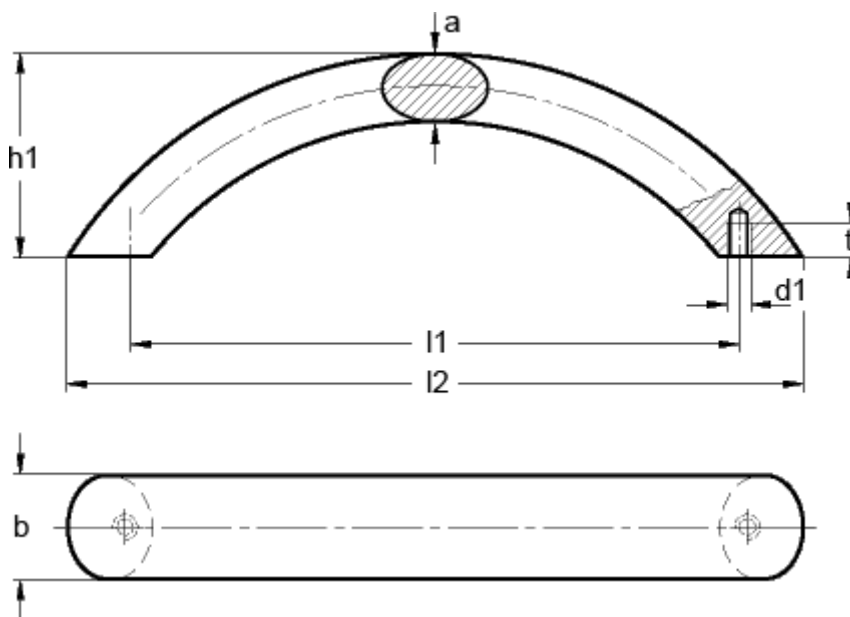

a	= 17
b	= 26
d1	= M8
h1	= 57
l1	= 160
l2	= 190
t min	= 12.0